

SORTLINK[™]
Automatic Cop-sorting system for winding

INDO TEXNOLOGY PVT LTD

Benefits

SORTLINKTM
Automatic Cop-sorting system for winding

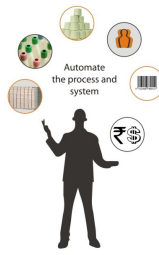

- ❖ The complete process of cop sorting is automated, avoiding manpower and possible errors.
- ❖ Potential to save 9 to 12 people per day , for a 25000 spindle mill (30s/40s Nec) with 8 or 9 Automatic winders



The Product

SORTLINKTM
Automatic Cop-sorting system for winding



Patent pending



INDO TECHNOLOGY[®]
Automate and Monitor to Lead

Operations

SORTLINKTM
Automatic Cop-sorting system for winding

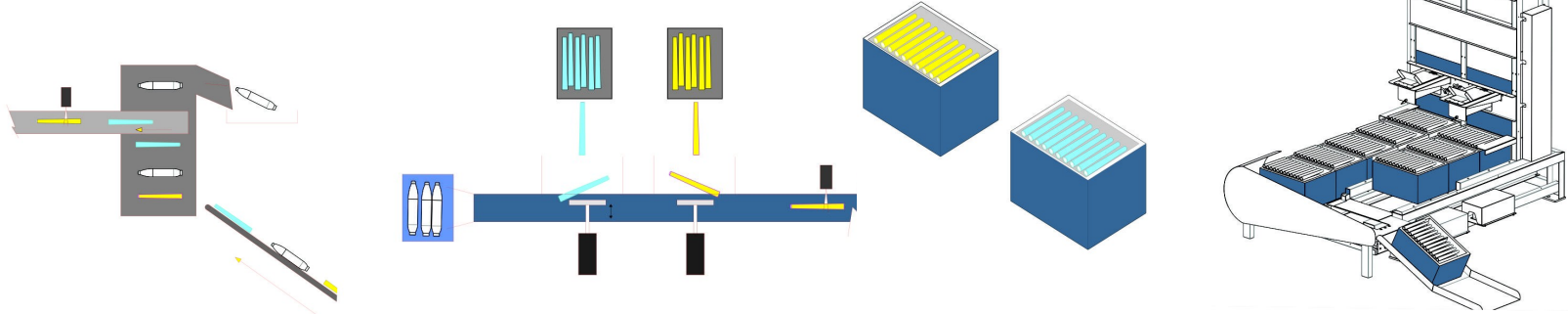

Operations

SORTLINKTM
Automatic Cop-sorting system for winding

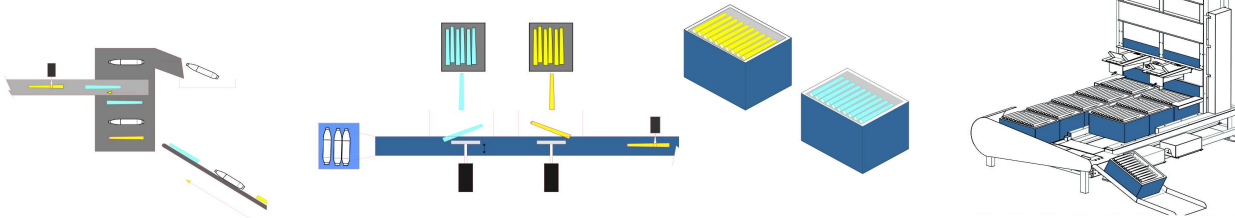
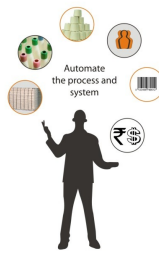

- ❖ Sorts cops of 2 different colours
- ❖ Segregates cops with remnant yarn or mixed colours if any
- ❖ Aligns to one uniform direction – cop tip to base
- ❖ Arranges pre-determined number of sorted and aligned cops into each set of crates .
- ❖ A crate manager has space to store 10 empty crates and 10 filling-in / filled crates .
- ❖ The filled in crates are automatically moved out and empty crates take the position to collect the sorted cops .
- ❖ The only manual function is to replenish the empty crates magazine and transport the filled crates (with sorted cops) periodically .

Operations

SORTLINKTM
Automatic Cop-sorting system for winding

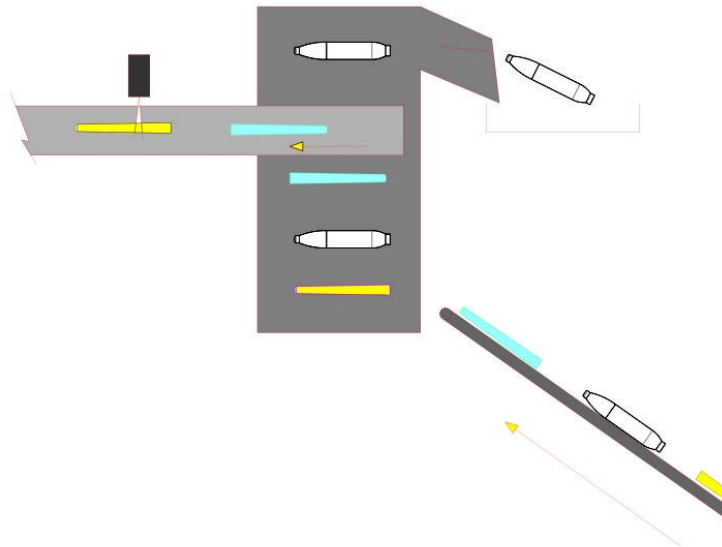

Segregating cops with
Remnant yarn

Operations

SORTLINKTM
Automatic Cop-sorting system for winding

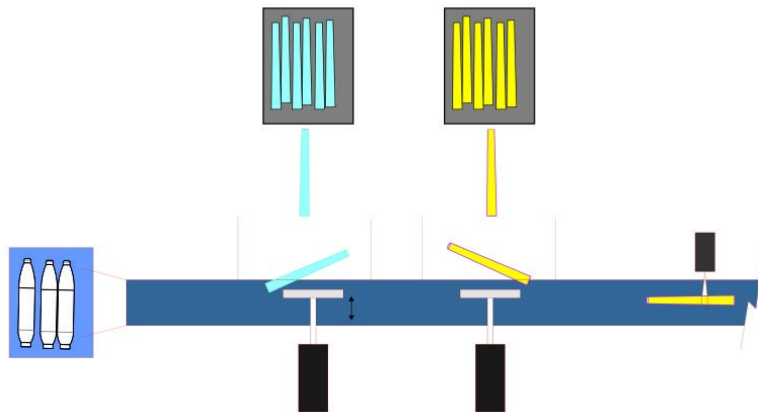

Sorting cops with different colours and aligning



Operations

SORTLINKTM
Automatic Cop-sorting system for winding

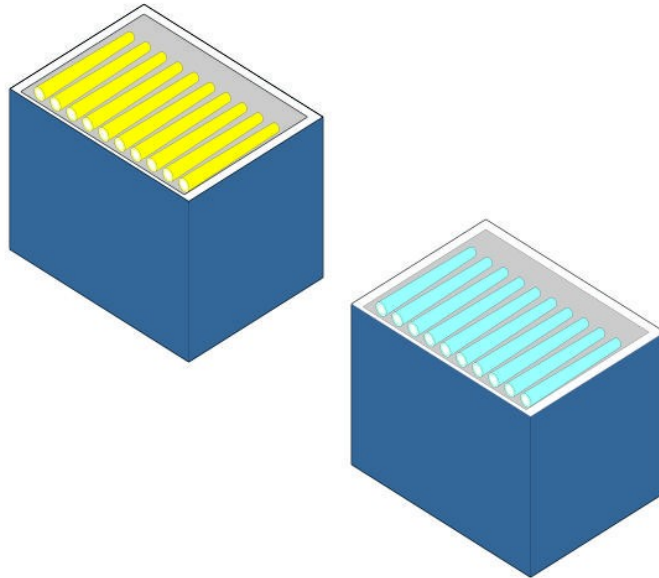

Filling the sorted and aligned cots in the crates



Operations

SORTLINKTM
Automatic Cop-sorting system for winding

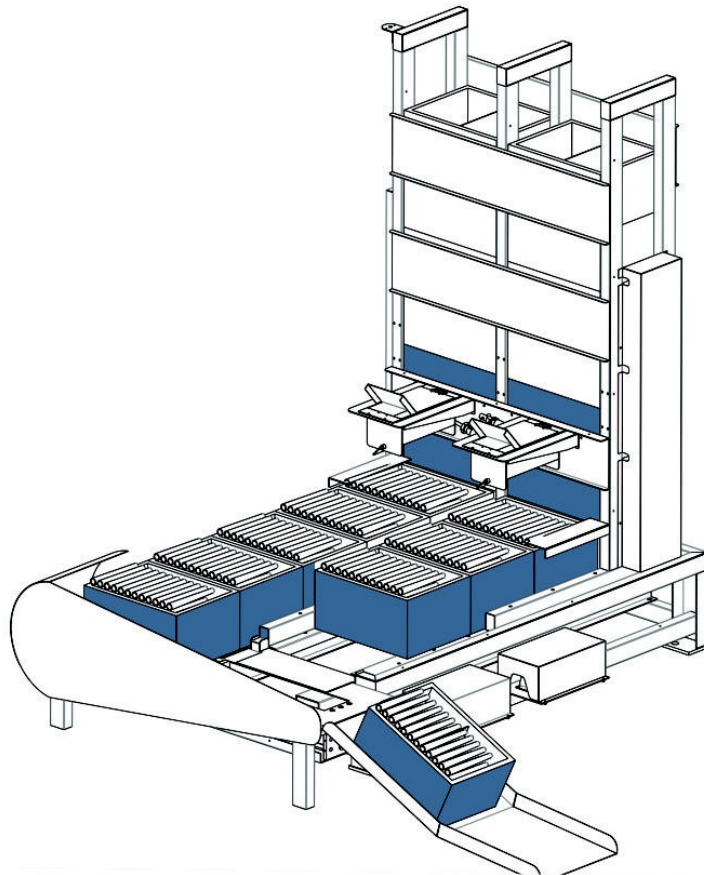

Crate Manager for empty crates and filled crates



INDO TECHNOLOGY[®]
Automate and Monitor to Lead

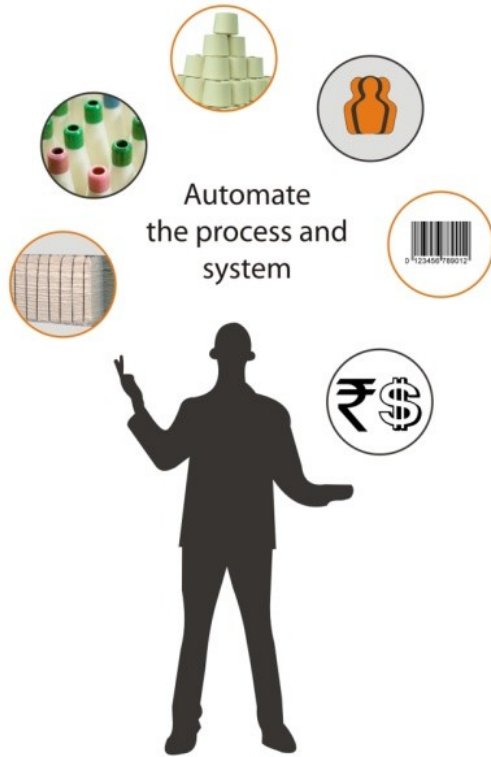

INDO TECHNOLOGY PRIVATE LIMITED

Office: 40, Thasami Park, Singanallur, Coimbatore
- 641005.

Ph: 0422 - 4348479.

Factory: 185, Aerodrome Road , Singanallur
Coimbatore - 641005.

Ph: 0422-3233345

info@indotexnology.com

www.indotexnology.com

